

English

OPERATING MANUAL

Temperature controller

LC4

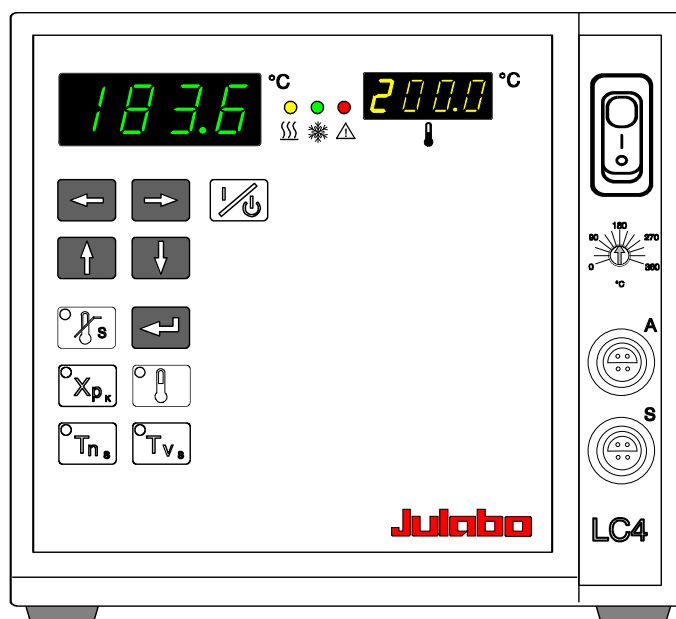

Julabo
THE TEMPERATURE CONTROL COMPANY

JULABO GmbH
77960 Seelbach / Germany
Tel. +49 (0) 7823 / 51-0
Fax +49 (0) 7823 / 24 91
info.de@julabo.com
www.julabo.com

1.951.5200-V3 05/16

19515200-V3.doc

26.04.2016

Congratulations!

You have made an excellent choice.

JULABO thanks you for the trust you have placed in us.

This operating manual has been designed to help you gain an understanding of the operation and possible applications of our circulators. For optimal utilization of all functions, we recommend that you thoroughly study this manual prior to beginning operation.

The JULABO Quality Management System



Temperature control devices for research and industry are developed, produced, and distributed according to the requirements of ISO 9001 and ISO 14001. Certificate Registration No. 01 100044846

Unpacking and inspecting

Unpack the circulator and accessories and inspect them for possible transport damage.

Damage should be reported to the responsible carrier, railway, or postal authority, and a damage report should be requested. These instructions must be followed fully for us to guarantee our full support of your claim for protecting against loss from concealed damage.

The form required for filing such a claim will be provided by the carrier.

Printed in Germany

Changes without prior notification reserved

Important: keep operating manual for future use

INDEX

OPERATING MANUAL.....	4
1. INTENDED USE.....	4
1.1. Description.....	4
2. OPERATOR RESPONSIBILITY – SAFETY RECOMMENDATIONS.....	4
2.1. Disposal.....	6
2.2. EC Conformity.....	7
2.3. Warranty conditions.....	8
2.4. Technical specifications.....	9
OPERATING INSTRUCTIONS.....	11
3. SAFETY NOTES FOR THE USER.....	11
3.1. Explanation of safety notes.....	11
3.2. Explanation of other notes.....	11
3.3. Safety recommendations.....	11
4. OPERATING CONTROLS AND FUNCTIONAL ELEMENTS.....	13
5. OPERATING PROCEDURES.....	15
5.1. Installation.....	15
5.2. Power connection.....	15
5.3. Connecting a heating device.....	16
5.4. Connecting the temperature sensors.....	16
5.5. Applications.....	17
5.6. Switching on / Start - Stop.....	18
5.7. Setting the temperatures.....	20
5.8. Setting the PID control parameters Xp, Tn and Tv.....	20
5.8.1. Optimization instructions for the PID control parameters.....	22
5.9. Setting the safety temperature (with shutdown function).....	23
6. MENU FUNCTIONS.....	24
6.1. Sensor calibration - ATC function.....	24
6.2. Temperature range: HL / LL.....	25
6.3. Parameter sets for control: PA.....	25
6.4. Active countercooling: Pc.....	27
6.5. Controlling the heater capacity: h.....	27
6.6. Interface parameters: r - br - P - H.....	28
7. TROUBLESHOOTING GUIDE / ERROR MESSAGES.....	29
8. ELECTRICAL CONNECTIONS.....	30
9. REMOTE CONTROL.....	32
9.1. Communication with a PC or a superordinated data system.....	32
9.2. List of commands.....	33
9.3. Status messages.....	35
9.4. Error messages.....	35
10. CLEANING / REPAIRING THE UNIT.....	36

Operating manual

1. Intended use

Fulfilling its principle task, reliable temperature control and measurement, the LC4 temperature controller also implements safety and monitoring functions, particularly in the areas of chemical research and quality control. The sophisticated capabilities of the unit allow wide application with electrical heating devices such as

heating hoods, heating baths,
heating pads and bandages,
water and oil baths.



JULABO Temperature controllers are not suitable for direct temperature control of foods, semi-luxury foods and tobacco, or pharmaceutical and medical products. Direct temperature control means unprotected contact of the object with the bath medium (bath fluid).

1.1. Description

Setting is rapid and simple using the keypad with its easy to learn symbols. Keypad is splash-proof, easily cleaned and ergonomically designed. The microprocessor technology allows the working temperature setpoint and five parameter sets to be stored and indicated on the MULTI-DISPLAY (LED).

The safety value for excess temperature protection, a safety installation independent from the control circuit, is adjustable on the front and visible on the MULTI-DISPLAY (LED).



The RS232C port permits modern process engineering without additional interface, directly on-line from the controller to your application equipment.

2. Operator responsibility – Safety recommendations

The products of JULABO ensure safe operation when installed, operated, and maintained according to common safety regulations. This section explains the potential dangers that may arise when operating the circulator and also specifies the most important safety precautions to preclude these dangers as far as possible.

- The operator is responsible for the qualification of the personnel operating the units.
- The personnel operating the units should be regularly instructed about the dangers involved with their job activities as well as measures to avert these dangers.
- Make sure all persons tasked with operating, installing, and maintaining the unit have read and understand the safety information and operating instructions.
- When using hazardous materials or materials that could become hazardous, the circulator may be operated only by persons who are absolutely familiar with these materials and the circulator. These persons must be fully aware of possible risks.

When using hazardous materials or materials that could become hazardous, **the operator must** affix the enclosed safety labels **(1 + 2)** to the front of the unit so they are highly visible:

1		Warning label W00: Colors: yellow, black Danger area. Attention! Observe instructions. (operating manual, safety data sheet)
2 or		Mandatory label M018: Colors: blue, white Carefully read the user information prior to beginning operation. Scope: EU
2		Semi S1-0701 Table A1-2 #9 Carefully read the user information prior to beginning operation. Scope: USA, NAFTA

Particular care and attention is necessary because of the wide operating range. There are thermal dangers:

Burn, scald, hot steam, hot parts and surfaces that can be touched.

	Warning label W26: Colors: yellow, black Hot surface warning. (The label is put on by JULABO)
--	---

Observe the instructions in the manuals for instruments of a different make that you connect to the circulator, particularly the respective safety recommendations. Also observe the pin assignment of plugs and technical specifications of the products.

2.1. Disposal



Valid in EU countries

See the current official journal of the European Union – WEEE directive. Directive of the European Parliament and of the Council on waste electrical and electronic equipment (WEEE).

This directive requires electrical and electronic equipment marked with a crossed-out trash can to be disposed of separately in an environmentally friendly manner.

Contact an authorized waste management company in your country.

Disposal with household waste (unsorted waste) or similar collections of municipal waste is not permitted!

2.2. EC Conformity

**EG-Konformitätserklärung gemäß EG Niederspannungs-Richtlinie 2006/95/EG,
Anhang III B; vom 12. Dez. 2006**
*EC-Declaration of Conformity in accordance with EC Low-Voltage Directive 2006/95/EC,
Annex III B, of 12. Dec. 2006*

Hersteller / Manufacturer:

JULABO GmbH
Gerhard-Juchheim-Strasse 1
77960 Seelbach / Germany
Tel: +49(0)7823 / 51 - 0



Hiermit erklären wir, dass das nachfolgend bezeichnete Produkt
We hereby declare, that the following product

Produkt / Product: Temperatur-Laborregler / *Laboratory Temperature Controller*

Typ / Type: LC 4

aufgrund seiner Konzipierung und Bauart in der von uns in Verkehr gebrachten Ausführung den grundlegenden Sicherheits- und Gesundheitsanforderungen den nachfolgend aufgeführten EG-Richtlinien entspricht.
due to the design and construction, as assembled and marketed by our Company – complies with fundamental safety and health requirements according to the following EC-Directives.

Niederspannungsrichtlinie 2006/95/EG; Low-Voltage Directive 2006/95/EC (bis zum / until 19. April 2016)

Niederspannungsrichtlinie 2014/35/EU; Low-Voltage Directive 2014/35/EU (vom / from 20. April 2016)

EMV-Richtlinie 2004/108/EG; EMC-Directive 2004/108/EC (bis zum / until 19. April 2016)

EMV-Richtlinie 2014/30/EU; EMC-Directive 2014/30/EU (vom / from 20. April 2016)

RoHS-Richtlinie 2011/65/EU; RoHS-Directive 2011/65/EU

Angewandte harmonisierte Normen und techn. Spezifikationen:

The above-named product is in compliance with the following harmonized standards and technical specifications:

EN 50581 : 2012

Technische Dokumentation zur Beurteilung von Elektro- und Elektronikgeräten hinsichtlich der Beschränkung gefährlicher Stoffe
Technical documentation for the assessment of electrical and electronic products with respect to the restriction of hazardous substances

EN 61010-1 : 2010

Sicherheitsbestimmungen für elektrische Mess-, Steuer-, Regel- und Laborgeräte, Teil 1: Allgemeine Anforderungen
Safety requirements for electrical equipment for measurement, control, and laboratory use, Part 1: General requirements

EN 61010-2-010 : 2014

Sicherheitsbestimmungen für elektrische Mess-, Steuer-, Regel- und Laborgeräte, Teil 2-010: Besondere Anforderungen an Laborgeräte für das Erhitzen von Stoffen
Safety requirements for electrical equipment for measurement, control, and laboratory use, Part 2-010: Particular requirements for laboratory equipment for the heating of materials

EN 61326-1 : 2013

Elektrische Mess-, Steuer-, Regel- und Laborgeräte- EMV-Anforderungen- Teil 1: Allgemeine Anforderungen
Electrical equipment for measurement, control, and laboratory use - EMC requirements - Part 1: General requirements

Das CE-Zeichen wurde angebracht
The CE marking was affixed

Seelbach, 25.02.2016

M. Juchheim, Geschäftsführer / *Managing Director*

2016_066_LC4_d_e.docx

2.3. Warranty conditions

JULABO GmbH warrants its products against defects in material or in workmanship, when used under appropriate conditions and in accordance with appropriate operating instructions

for a period of ONE YEAR.

Extension of the warranty period – free of charge



With the '1PLUS warranty' the user receives a free of charge extension to the warranty of up to 24 months, limited to a maximum of 10 000 working hours.

To apply for this extended warranty the user must register the unit on the JULABO web site www.julabo.com, indicating the serial no. The extended warranty will apply from the date of JULABO GmbH's original invoice.

JULABO GmbH reserves the right to decide the validity of any warranty claim. In case of faults arising either due to faulty materials or workmanship, parts will be repaired or replaced free of charge, or a new replacement unit will be supplied.

Any other compensation claims are excluded from this guarantee.

2.4. Technical specifications

		LC4	
Adjustable temperature range	°C	-50 ... 350	
Display accuracy	%	±0.5 ± 1 Digit	
Temperature stability (depending on substances in the bath)	°C	>±0.05	
Temperature selection		digital	
via keypad		indication on MULTI-DISPLAY (LED)	
remote control via computer		indication on monitor	
Temperature display		MULTI-DISPLAY (LED): 4-digit Working temperature: 4-digit	
Resolution	°C	0.1	
ATC function	°C	±9.99	
Temperature control		PID	
with 5 parameter sets		freely selectable	
Working temperature sensor		Pt100, 4-lead technique	
Safety temperature sensor		Pt100, 4-lead technique	
Electrical connections:			
External alarm		24-0 V DC / max. 25 mA	
Interface		RS232C	
Mains power socket			
for heating device (at 115 V)	W	max. 1000; resistive load	
or (at 230 V)	W	max. 2000; resistive load	
Overall dimensions (WxDxH)	cm	17 x 17 x 16	
Weight	kg	3	
Ambient temperature	°C	5 ... 40	
Mains power connection ±10%	V/Hz	230 / 50/60	
Mains power connection ±10%	V/Hz	115 / 60	
Current draw	A	10	
Total power consumption	W	max. 1050 (at 115 V)	
Total power consumption	W	max. 2050 (at 230 V)	

All measurements have been carried out at
 rated voltage and frequency
 ambient temperature 20 °C

Technical changes without prior notification reserved.

Operator responsibility – Safety recommendations

Safety installations according to IEC 61010-2-010:

Excess temperature protection 0 °C ... 350 °C

Supplementary safety installations:

Supervision of the working sensor

plausibility control

Alarm indication

optical + audible (continuous tone)

Environmental conditions according to EN 61 010, part 1:

Use only indoor.

Altitude up to 2000 m - normal zero.

Ambient temperature: +5 ... +40 °C (for storage and transportation)

Air humidity:

Max. rel. humidity 80 % for temperatures up to +31 °C,

linear decrease down to 50 % relative humidity at a temperature of +40 °C

Max. mains fluctuation of ± 10 % are permissible.

Protection class according to EN 60 529

IP31

The unit corresponds to Class I

Overvoltage category II

Pollution degree 2



Caution:

The unit is not for use in explosive environment.

Standards for interference resistance according to EN 61326-1

This unit is an ISM device classified in Group 1 (using high frequency for internal purposes)

Class A (industrial and commercial range).

Operating instructions

3. Safety notes for the user

3.1. Explanation of safety notes



In addition to the safety warnings listed, warnings are posted throughout the operating manual. These warnings are designated by an exclamation mark inside an equilateral triangle. "Warning of a dangerous situation (Attention! Please follow the documentation)."

The danger is classified using a signal word.

Read and follow these important instructions for averting dangers.



Warning:

Describes a **possibly** highly dangerous situation. If these instructions are not followed, serious injury and danger to life could result.



Caution:

Describes a **possibly** dangerous situation. If this is not avoided, slight or minor injuries could result. A warning of possible property damage may also be contained in the text.



Notice:

Describes a **possibly** harmful situation. If this is not avoided, the product or anything in its surroundings can be damaged.

3.2. Explanation of other notes



Note!

Draws attention to something special.



Important!

Indicates usage tips and other useful information.

3.3. Safety recommendations

Follow the safety recommendations to prevent damage to persons or property. Further, the valid safety instructions for working places must be followed.



- Only connect the unit to a power socket with earthing contact (PE – protective earth)!
- The power supply plug serves as a safe disconnecting device from the line and must always be easily accessible.
- Place the instrument on an even surface on a pad made of **non-inflammable** material.
- Do not stay in the area below the unit.
- Make sure you read and understand all instructions and safety precautions

listed in this manual before installing or operating your unit.

- Never operate the unit without bath fluid in the bath.
- Observe the flash point of the bath medium used. The excess temperature protection should be set at least 25 °C below the fire point.
- Set up the heating device according to the instructions prior to connection to the controller and ensure secure attachment to the bath.
Danger of burning and fire!
- Immerse both temperature sensors in the bath medium and ensure secure attachment.
- Check the filling level of the bath fluid from time to time. The heater must always be fully covered with the bath fluid!
- Never operate damaged or leaking equipment.
- Always turn off the unit and disconnect the mains cable from the power source before performing any service or maintenance procedures, or before moving the unit.
- Sudden jolts or drops may cause damage in the interior of the unit.
- Always empty the bath before moving the unit.
- Transport the unit with care.
- Never operate equipment with damaged mains power cables.
- Observe all warning labels.
- Never remove warning labels.
- Always turn off the unit and disconnect the mains cable from the power source before cleaning the unit.
- Repairs are to be carried out only by qualified service personnel.







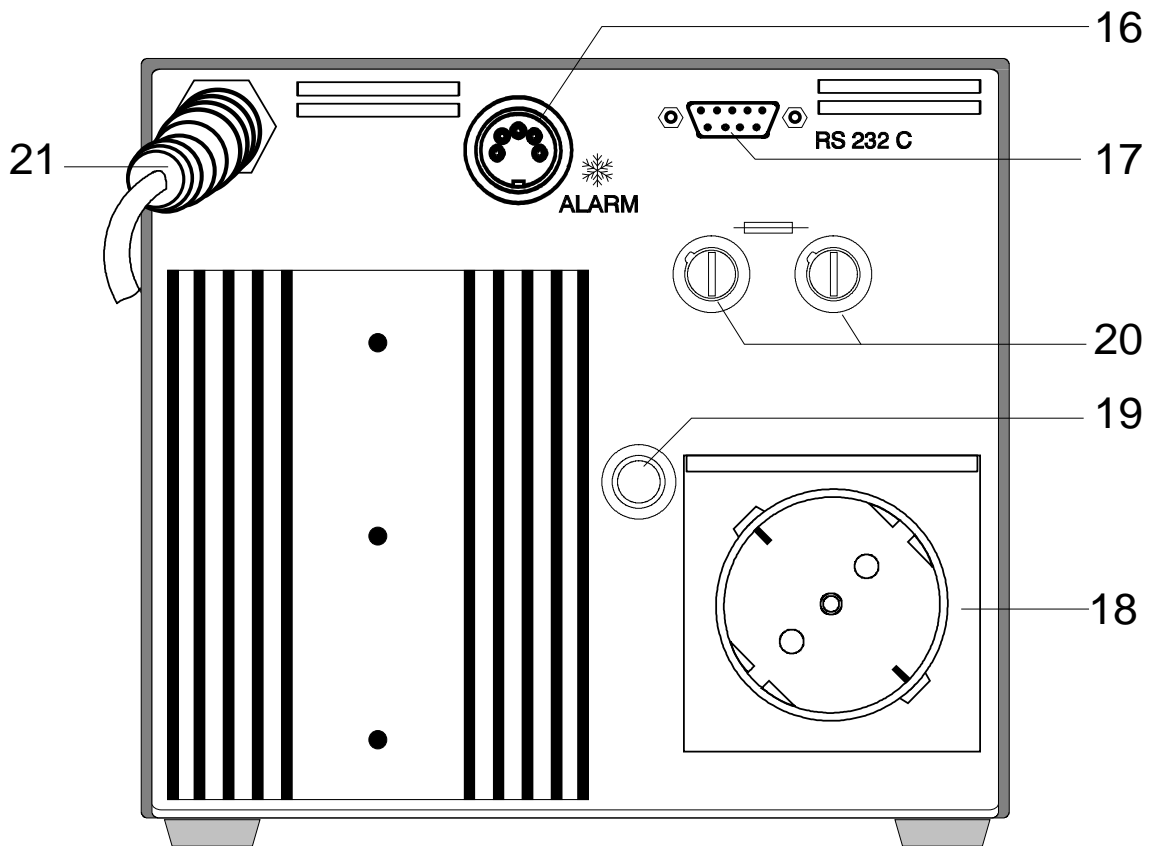
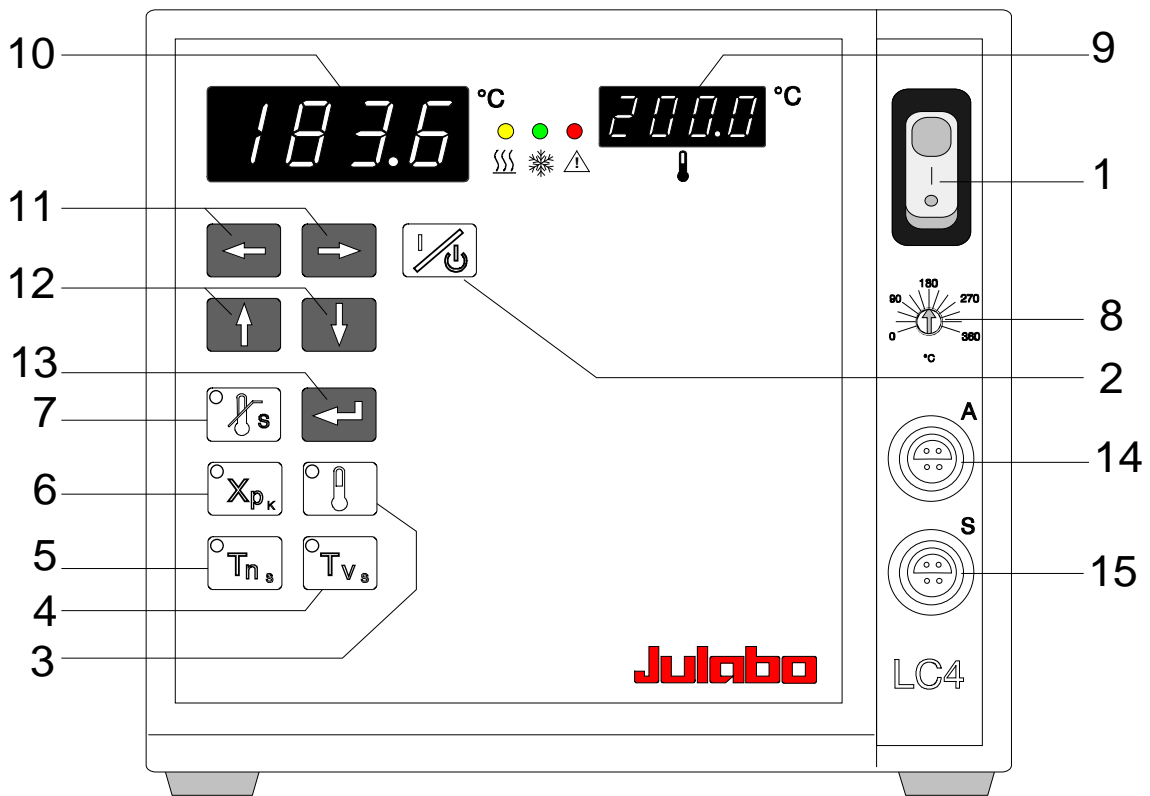











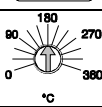

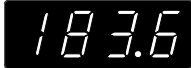
- Some parts of the bath cover may become extremely warm during continuous operation. Therefore, exercise particular caution when touching these parts. Use safety glasses!

4. Operating controls and functional elements



Rear view

Operating controls and functional elements

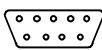
1		Mains power switch, illuminated
2		Start / stop key
3		Working temperature setpoint
4		Control parameter Tv (lead time)
5		Control parameter Tn (resetting time)
6		Control parameter Xp (proportional range)
7		Safety temperature
8		Adjustable excess temperature protection (safety temperature)
9		Indication of working temperature
10		MULTI-DISPLAY (LED) temperature indication
		Indicator light - Alarm
		Indicator light - Cooling
		Indicator light - Heating
11		Cursors left/right
12		Edit keys (increase/decrease setting)
13		Enter key (store)
14		Connector: Working sensor A
15		Connector: Safety sensor S
16		Connector: ❄️ / alarm output
17		RS232C interface
18		Grounded mains socket for heating device
19		Threaded fitting (10 mm) for stand rod attachment
20		Mains fuses, fuse holders
21		Mains power cable with plug

5. Operating procedures

5.1. Installation

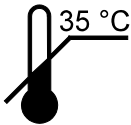

- The unit should be set up at a dry location.
- the unit in an upright position and do not obstruct the ventilation.
- A wall distance of at least 10 cm must be maintained for ventilation, allowing internal heat to be conducted away from the unit.
- If one or more temperature controllers are set up in a cabinet for example, take care of good ventilation (waste heat per unit = approx. 60 Watts).
- The ambient temperature must not exceed 35 °C. Ambient temperatures above 35 °C result in a failure of the unit.
- Do not set up the unit in the immediate vicinity of heat sources and do not expose to sun light.

5.2. Power connection



Caution:

- Only connect the unit to a power socket with earthing contact (PE – protective earth)!
- The power supply plug serves as safe disconnecting device from the line and must be always easily accessible.
- Never operate equipment with damaged mains power cables.
- Regularly check the mains power cables for material defects (e.g. for cracks).
- We disclaim all liability for damage caused by incorrect line voltages!

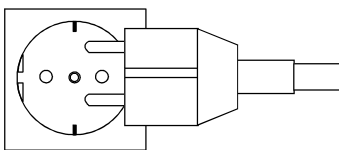

Make sure that the line voltage and frequency match the supply voltage specified on the type plate.

Deviations of $\pm 10\%$ are permissible.

5.3. Connecting a heating device



Caution:

Set up the heating device according to the instructions or securely fix the unit in the bath tank using appropriate means. Danger of burning and fire!

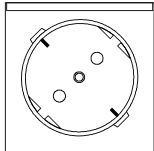

Connect the power plug to the grounded mains socket (18) on the rear of the controller.



Caution:

Max. resistive load 1000 W at 115 V / 2000 W at 230 V.
Max. current 5 A at 115 V / 10 A at 230 V.

5.4. Connecting the temperature sensors

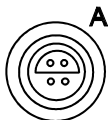

A

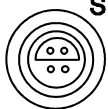

S

Connect both sensors prior to turning the unit on since an alarm shutoff will be effected if the sensors are not connected (see page 29).

Connect the working sensor to the socket "A" (14) and the safety sensor to socket "S" (15) .

Sensor calibration:

When the controller is first placed into operation or whenever a sensor is replaced, a working sensor calibration must be carried out (ATC - see page 24).



Caution:

Place both sensors into the bath medium and securely fix the sensors.

5.5. Applications

Directly heated bath liquid:

- The bath liquid is directly heated via the heating device.
- Working and safety sensors must both be immersed in the bath liquid.
- Whenever countercooling is necessary (in case of temperature application near the ambient temperature), cooling in the bath is performed through a cooling coil connected to a solenoid valve and the MVS controller.

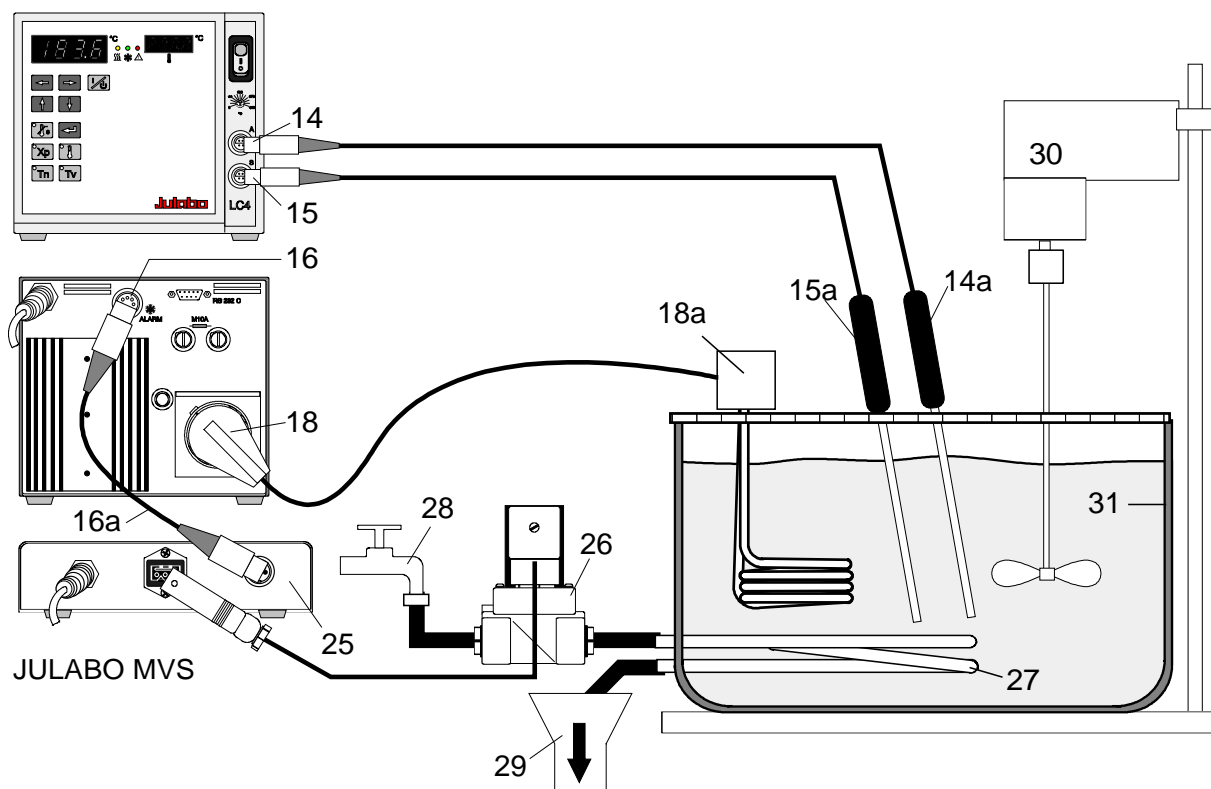

- | | | | |
|----|---|-----|-------------------------------|
| 14 | Connector: Working sensor | 14a | Working sensor |
| 15 | Connector: Safety sensor | 15a | Safety sensor |
| 16 | Connector for control cable | 16a | Control cable for MVS |
| 18 | Mains socket for heating device | 18a | Heating device / heating hood |
| 25 | MVS solenoid valve controller (order no. 9 790 000) | | |
| 26 | Solenoid valve 220 Volts (order no. 8 980 700) | | |
| 27 | Cooling coil | | |
| 28 | Tap water connection | | |
| 29 | Cooling water drain | | |
| 30 | Stirrer motor for bath circulation | | |
| 31 | Bath tank / round bottom flask with bath liquid | | |

Indirectly heated bath liquid:

- The bath liquid is indirectly heated.
- Working and safety sensors must both be immersed in the bath liquid.

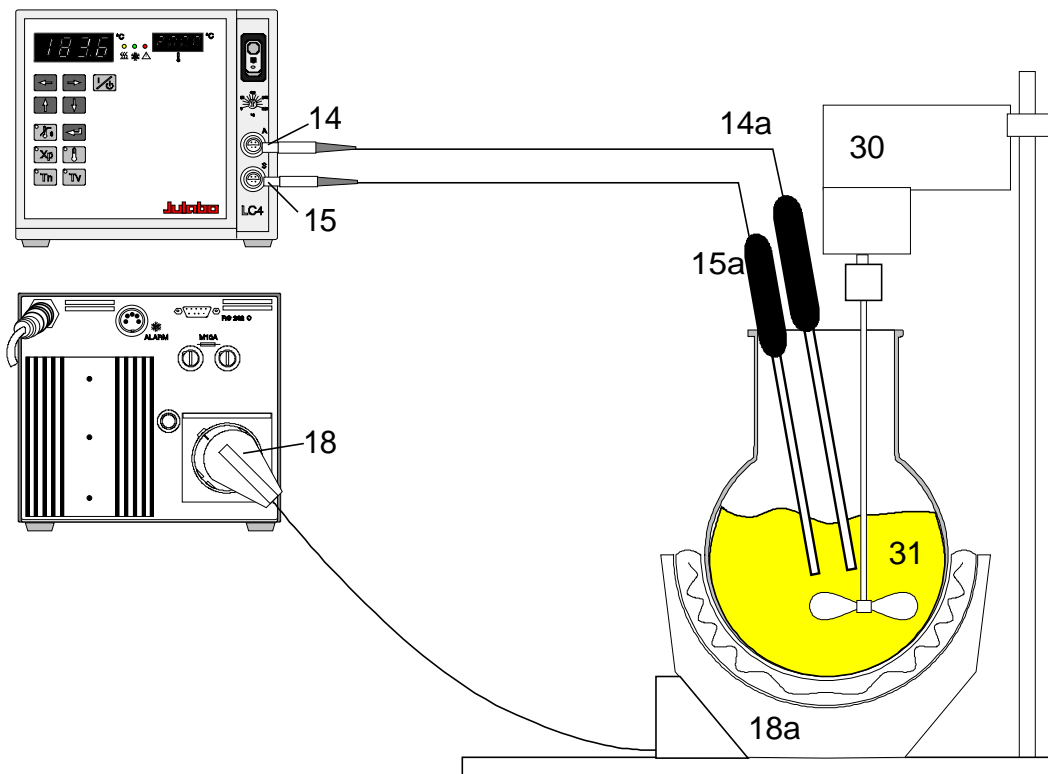

5.6. Switching on / Start - Stop

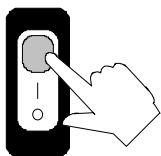

Switching on:

Turn on the mains power switch.

The unit performs a self-test. A signal sounds, and all segments of the two 4-digit displays as well as all indicator lights will illuminate.



Then the software version (example: n 1.0) and the model description "LC 4" appear.



The display "OFF" or "r OFF" indicates the controller is ready to operate. Also the effective working temperature setpoint is indicated (example: 20.0 °C).

The controller enters the operating mode activated before switching the controller off, **keypad control mode** (manual operation) or **remote control mode** (operation via personal computer).



Start:

- Press the start/stop key.
 - The MULTI-DISPLAY (LED) indicates the actual bath temperature. (example: 21.0 °C)
 - The indicator light in the setpoint key  illuminates.



Temperature control is carried out according to the parameter set last effective (see page 25).

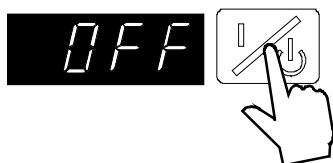

Stop:

- Press the start/stop key.
 - The MULTI-DISPLAY (LED) indicates the message "OFF".



The unit also enters the safe operating state "OFF" or "r OFF" after a mains power interruption. The temperature values entered via the keypad remain in memory. With the controller in keypad control mode, press the start/stop key to restart operation. With the controller in remote control mode, the personal computer must first resend the parameters set via the interface before operation of the controller may be restarted.

5.7. Setting the temperatures

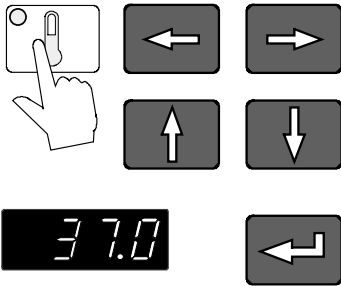

Setting the working temperature:

1. Press the setpoint key .
The indicator light blinks and the effective value appears on the MULTI-DISPLAY (LED).
2. Use the cursor keys to move left or right on the display until the numeral you wish to change is blinking.
3. Use the increase/decrease arrows to change the selected numeral (-, 0, 1, 2, 3, ... 9).
4. Press enter to store the selected value (example: 37.0 °C).

The working temperature is maintained constant after a short heat-up time (example: 37.0 °C).

5.8. Setting the PID control parameters Xp, Tn and Tv

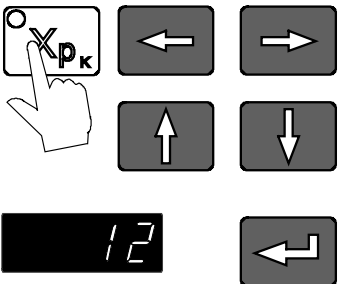

Setting the Xp (proportional range)

1. Press the key .
The indicator light **blinks** and the effective Xp value appears on the MULTI-DISPLAY (LED).
2. Use the cursor keys to move left or right on the display until the numeral you wish to change is blinking.
3. Use the increase/decrease arrows to change the selected numeral (-, 0, 1, 2, 3, ... 9).
4. Press enter to store the selected value (example: 12 °C).

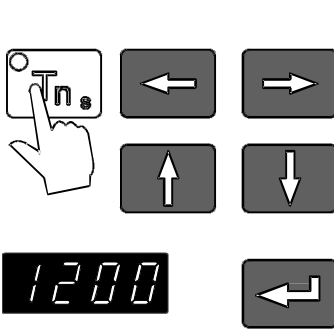

Setting range for the Xp parameter: 0.1 to 50 °C

Setting the Tn (resetting time)

1. Press the key . The indicator light **blinks** and the effective value for Tn appears on the MULTI-DISPLAY (LED).
2. Follow the instructions
3. for
4. (example: 1200 s).



Setting range for Tn: 1 to 9998 s.

With Tn set to 9999, the integral part of the controller is deactivated (use of a P or PD type controller).

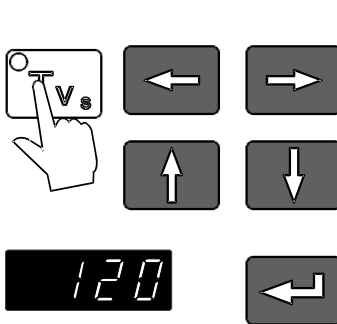
Setting the Tv (lead time)

1. Press the key . The indicator light **blinks** and the effective value for Tv appears on the MULTI-DISPLAY (LED).
2. Follow the instructions
3. for
4. (example: 120 s).



Setting range for Tv: 0 to 1000 s.

With Tv set to 0 eingestellt, the differential part of the controller is deactivated (use of a P or PI type controller).

5.8.1. Optimization instructions for the PID control parameters

The heat-up curve reveals inappropriate control settings.

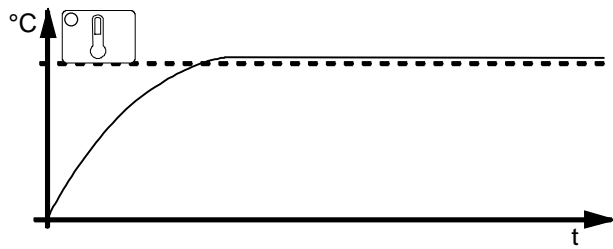

optimum setting

Inappropriate settings may produce the following heat-up curves:

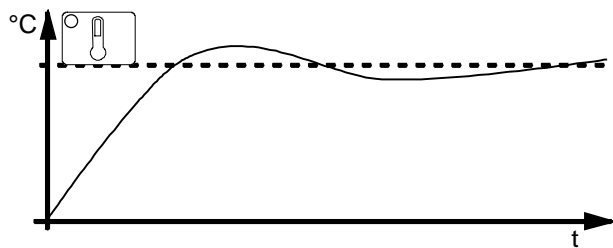

X_p too low

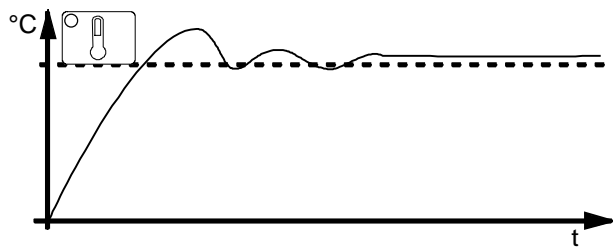

T_v/T_n too low

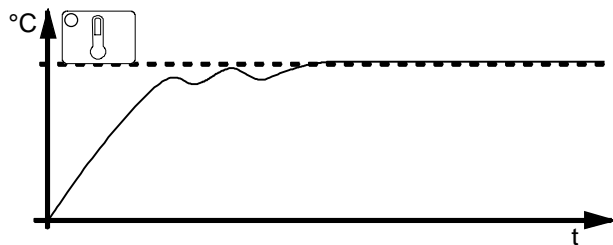

X_p or T_v too high

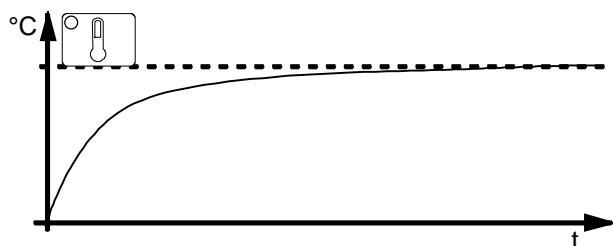

T_v/T_n or X_p too high

5.9. Setting the safety temperature (with shutdown function)

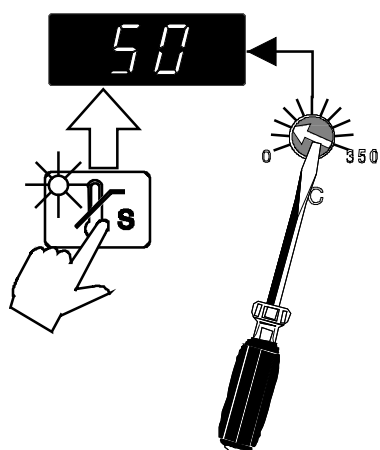

(excess temperature protection)

- Press the key to indicate the safety temperature value on the MULTI-DISPLAY and using a screwdriver simultaneously turn the setting screw to the desired value (example: 50 °C).

Setting range: 0 °C to 360 °C
in 2 °C steps

This safety installation is independent of the control circuit. As soon as this safety installation is triggered, a complete shutdown of the connected heating device is effected.

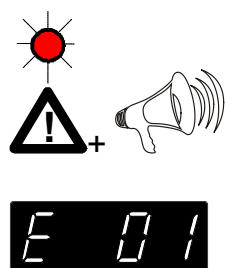

The alarm is indicated by optical and audible signals (continuous tone)

and on the MULTI-DISPLAY (LED) appears the error message "Error 01".

Recommendation:

Set the safety temperature at 5 to 10 °C above the working temperature setpoint.



The excess temperature protection should be set at least 25 °C below the fire point of the bath liquid used!





In the event of wrong setting there is a fire hazard!

We disclaim all liability for damage caused by wrong settings!

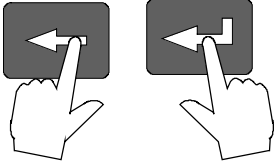
6. Menu functions

Parameters and values are set via the menu level that may be selected at any time.



- Enter or exit the menu level by pressing the left arrow  and enter  at the same time.
- Using the cursor keys   select the menu functions one by one.

6.1. Sensor calibration - ATC function









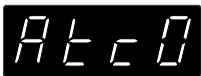

Controller (TT)



Calibration bath (TM)



The ATC (Absolute Temperature Calibration) function serves to calibrate the working sensor.

- Place the working sensor "A" and the temperature sensor of a thermometer in the calibration bath.
- Determine the difference temperature ($\Delta T = T_M - T_T$) and store as correcting factor (example $\Delta T = -0.26 \text{ }^\circ\text{C}$) as follows:
- With the edit keys   change the menu function from "Atc 0" to "Atc 1" and then press enter .
- Using the cursor keys   and the edit keys   set the correcting factor (example $-0.26 \text{ }^\circ\text{C}$) and then press enter .

After exiting the menu level, the corrected value (example: $36.7 \text{ }^\circ\text{C}$) is indicated on the MULTI-DISPLAY (LED).



Recommendation:

In case a calibrated temperature measuring instrument is used, the ATC function allows the controller to be used as testing instrument according to ISO 9000.

6.2. Temperature range: HL / LL

The laboratory controller LC4 features the possibility to limit the working temperature range to protect thermally sensitive substances.

Setting the upper limit



- With the edit keys change the menu function from "HL 0" to "HL 1" and then press enter .
- Using the cursor keys and the edit keys set the upper limit (example: 250.0 °C) and then press enter .

HL (High Limit) factory-setting: 350.0 °C

Setting the lower limit

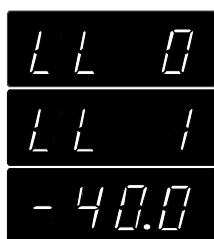

- With the edit keys change the menu function from "LL 0" to "LL 1" and then press enter .
- Using the cursor keys and the edit keys set the lower limit (example: -40.0 °C) and then press enter .

LL (Low Limit) factory-setting: -50.0 °C

6.3. Parameter sets for control: PA

The LC4 provides 5 different parameter sets for controlled processes.

Selecting a parameter set for control:



- Press the edit keys to select the desired parameter set (1 to 5) and then press enter . (example: parameter set 3).



For each parameter set, the control parameters X_p , T_n and T_v may be individually modified and stored (see page 20).

Preference:

Quick access to parameters determined during previous applications.

		Factory-preset parameter sets for the following controlled processes:
Set 1:	$X_p = 4\text{ °C}$ $T_n = 150\text{ s}$ $T_v = 10\text{ s}$	Directly heated liquid bath Filling volume: 4.5 litres of water Setpoint temperature: 70 °C Heater capacity: 2000 W
Set 2	$X_p = 10\text{ °C}$ $T_n = 300\text{ s}$ $T_v = 25\text{ s}$	Directly heated liquid bath Filling volume: 4 litres of Thermal H Setpoint temperature: 150 °C Heater capacity: 2000 W
Set 3	$X_p = 20\text{ °C}$ $T_n = 1800\text{ s}$ $T_v = 165\text{ s}$	Heating hood model JH2000 with 2000 ml round bottom flask Filling volume: 2 litres of water Setpoint temperature: 70 °C Heater capacity: 480 W (stage III)
Set 4	$X_p = 35\text{ °C}$ $T_n = 1800\text{ s}$ $T_v = 130\text{ s}$	Heating hood JM500 with 500 ml round bottom flask Filling volume: 0.5 litres of water Setpoint temperature: 70 °C Heater capacity: 150 W (stage II)
Set 5	$X_p = 15\text{ °C}$ $T_n = 1550\text{ s}$ $T_v = 120\text{ s}$	Heating hood JM500 with 500 ml round bottom flask Filling volume: 0.5 litres of Thermal H Setpoint temperature: 100 °C Heater capacity: 150 W (stage II)

6.4. Active countercooling: Pc





For applications near the ambient temperature, countercooling might become necessary.

For this purpose, connect the JULABO MVS solenoid valve controller to the  / alarm socket (application example see page 17). The supply of a cooling pulse "Pc" must be activated on the controller.



Activating the supply of a cooling pulse:

- With the edit keys   change the menu function from "Pc 0" to "Pc 1" and then press enter .

Factory setting: "Pc 0" (no countercooling).







- Whenever countercooling is not necessary, reset the "Pc" parameter to 0.

6.5. Controlling the heater capacity: h

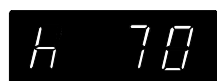
This control allows the maximum effective heater capacity of the connected heating device to be adjusted in 10 % steps between 10 % and 100 %. The gradient of the temperature rise function may thus be controlled to permit gentle warming of thermally sensitive substances and to prevent over-shooting.

Controlling the heater capacity:



- Using the edit keys   set the desired maximum heater capacity and then press enter . (example: 70 %).

Factory setting: 100 %

6.6. Interface parameters: r - br - P - H



Whenever the parameter setting of the controller is not conform to those of the connected personal computer, a modification is necessary.



Factory setting of the RS232 interface:

Baudrate: 4800 Bauds

Parity: 2 (even)

Handshake: 1 (Hardware handshake)

Data bits: 7

Stop bits: 1



- Press the cursor key until the desired parameter appears on the MULTI-DISPLAY (LED).
- Use the edit keys to set the desired parameter and then press enter .

Adjustable interface parameters



REMOTE 0 = keypad control mode
1 = remote control mode via RS232C



BAUDRATE 12 = 1200 bauds
24 = 2400 bauds
48 = 4800 bauds
96 = 9600 bauds



PARITY 0 = no parity
1 = odd
2 = even



HANDSHAKE
0 = Protocol Xon/Xoff (software handshake)
1 = Protocol RTS/CTS (hardware handshake)



Like all parameters which can be entered through the keypad, interface parameters are stored in memory even after the controller is turned off.

7. Troubleshooting guide / Error messages

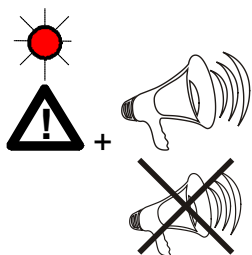

Whenever the microprocessor electronics registers a failure, a complete shutdown of the heating device connected to the controller is performed. The alarm light "▲" illuminates and a continuous signal tone sounds.

Press enter  to turn off the signal tone.



Cause	Remedy
<ul style="list-style-type: none"> The safety temperature value lies below the working temperature setpoint. A sudden temperature increase, e.g. caused by the immersion of preheated samples. 	<p>Set the safety temperature to a higher value.</p> <p>Set the safety temperature to a higher value.</p>



After eliminating the malfunction, press the mains power switch off and on again to cancel the alarm state.

- The wires of the working temperature sensor are interrupted or short-circuited.



}
}
} other errors

After eliminating the malfunction, press the mains power switch off and on again to cancel the alarm state.

If the error reappears, contact an authorized JULABO service station. If necessary have the unit checked by a JULABO service technician.

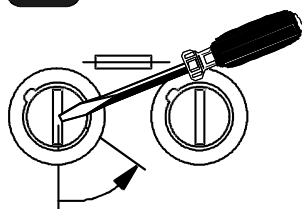

Mains fuses

- The mains fuses on the rear of the unit may easily be exchanged as shown on the left.
(Fine fuse T 10.0 A, dia. 5 x 20 mm)



Warning:

Before exchanging the fuses, turn off the mains power switch and disconnect the power plug from the mains socket!

Use only fine fuses with the specified nominal value.

8. Electrical connections

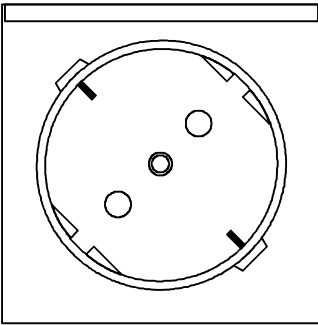

Grounded mains socket

Connector for heating device

- Maximum 1000 W resistive load at 115 V.
Maximum current 5 A.
- Maximum 2000 W resistive load at 230 V.
Maximum current 10 A.



Notice:

Use shielded cables only.

The shield of the connecting cable is electrically connected to the plug housing.

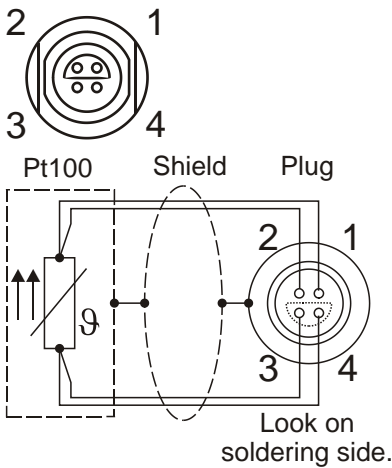

Connectors for temperature sensors

Pin assignment:

- Pin 1 Current +
- Pin 2 Voltage +
- Pin 3 Voltage -
- Pin 4 Current -

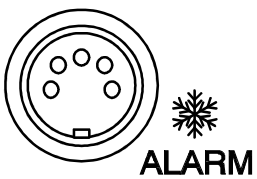

❄️/ ALARM - connector

The "❄️ ALARM" connector may be used as output for alarm messages.

Circuit: Operation = relay powered
Alarm = relay not powered

Pin assignment:

- Pin 1: +24 V (max. current 25 mA)
- Pin 2: 0 V
- Pin 3: 0 V / alarm relay
- Pin 4: Reserved - do not use!
- Pin 5: Cooling pulse

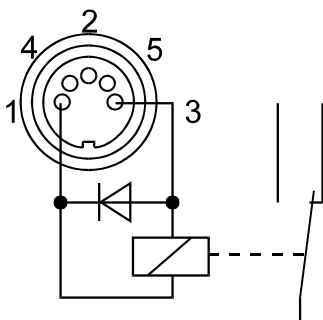

**RS 232 C****RS232C serial interface**

This port can be used to connect a computer with an RS232C cable for remote control of the controller.

**RS232C****RS232 serial interface**

This port can be used to connect a computer with an RS232 cable for remote control of the circulator.

Pin assignments RS232:

Pin 2	RxD	Receive Data
Pin 3	TxD	Transmit Data
Pin 5	0 V	Signal GND
Pin 7	RTS	Request to send
Pin 8	CTS	Clear to send

Pin 1; 4; 6, 9 Reserved - do not use!

RS232 interface cable

<u>Circulator (9-pol)</u>		<u>PC (9-pol)</u>
Pin 2 RxD	↔	Pin 3 TxD
Pin 3 TxD	↔	Pin 2 RxD
Pin 5 GND	↔	Pin 5 GND
Pin 7 RTS	↔	Pin 8 CTS
Pin 8 CTS	↔	Pin 7 RTS

Accessories:**Order No.****Description**

8 980 073	RS232 interface cable 9-pol./9-pol. , 2,5 m
8 900 110	USB interface adapter cable

9. Remote control

9.1. Communication with a PC or a superordinated data system

Suitable terminal programs for communicating with a PC are:

- MS-Windows - TERMINAL.EXE (included with MS-Windows).



If the controller is put into remote control mode via the configuration level, the display will read "r OFF" = REMOTE STOP. The controller is now operated via the computer.

In general, the computer (master) sends commands to the controller (slave). The controller sends data (including error messages) only when the computer asks for it.

A transfer sequence consists of:

- Command
- space (\leftrightarrow ; Hex: 20)
- parameter (the character separating decimals in a group is the period)
- End of file (\downarrow ; Hex: 0D)

The commands are divided into **in** and **out** commands.

in commands: asking for parameters to be displayed

out commands: setting parameters



The out commands are valid only in remote control mode.

Examples:

- Command to set the working temperature to 55.5 °C:
out_sp_00 \leftrightarrow 55.5 \downarrow
- Command to ask for the working temperature:
in_sp_00 \downarrow
- Response from the controller:
55.5 \downarrow

9.2. List of commands

Befehl	Parameter	Description
version	none	Number of software version (V X.xx)
status	none	Status message, error message (see page 35)
out_mode_05	0	Stop the controller = r OFF
out_mode_05	1	Start the controller
out_mode_02	1	Parameter set 1 effective for control
out_mode_02	2	Parameter set 2 effective for control
out_mode_02	3	Parameter set 3 effective for control
out_mode_02	4	Parameter set 4 effective for control
out_mode_02	5	Parameter set 5 effective for control
in_mode_02	none	Ask for effective parameter set
out_sp_00	xxx.x	Set working temperature
in_sp_00	none	Ask for working temperature
in_pv_00	none	Ask for effective value registered by working sensor
in_pv_01	none	Ask for effective heater capacity
out_par_00	xxx.x	Set Xp of parameter set 1
in_par_00	none	Ask for Xp of parameter set 1
out_par_01	xxx.x	Set Tn of parameter set 1
in_par_01	none	Ask for Tn of parameter set 1
out_par_02	xxxx.x	Set Tv of parameter set 1
in_par_02	none	Ask for Tv of parameter set 1
out_par_03	xxx.x	Set Xp of parameter set 2
in_par_03	none	Ask for Xp of parameter set 2

Command	Parameter	Description
out_par_04	xxx.x	Set Tn of parameter set 2
in_par_04	none	Ask for Tn of parameter set 2
out_par_05	xxxx.x	Set Tv of parameter set 2
in_par_05	none	Ask for Tv of parameter set 2
out_par_06	xxx.x	Set Xp of parameter set 3
in_par_06	none	Ask for Xp of parameter set 3
out_par_07	xxx.x	Set Tn of parameter set 3
in_par_07	none	Ask for Tn of parameter set 3
out_par_08	xxxx.x	Set Tv of parameter set 3
in_par_08	none	Ask for Tv of parameter set 3
out_par_09	xxx.x	Set Xp of parameter set 4
in_par_09	none	Ask for Xp of parameter set 4
out_par_10	xxx.x	Set Tn of parameter set 4
in_par_10	none	Ask for Tn of parameter set 4
out_par_11	xxxx.x	Set Tv of parameter set 4
in_par_11	none	Ask for Tv of parameter set 4
out_par_12	xxx.x	Set Xp of parameter set 5
in_par_12	none	Ask for Xp of parameter set 5
out_par_13	xxxx.x	Set Tn of parameter set 5
in_par_13	none	Ask for Tn of parameter set 5
out_par_14	xxxx.x	Set Tv of parameter set 5
in_par_14	none	Ask for Tv of parameter set 5

9.3. Status messages

Message	Description
00 MANUAL STOP	Controller in "OFF" state
01 MANUAL START	Controller in keypad control mode
02 REMOTE STOP	Controller in "r OFF" state
03 REMOTE START	Controller in remote control mode

9.4. Error messages

Message	Description
-01 SAFETY-TEMP ALARM	Safety temperature alarm
-05 TEMPERATURE MEASUREMENT ALARM	Error in measuring system.
-07 I ² C-BUS WRITE ERROR -07 I ² C-BUS READ ERROR -07 I ² C-BUS READ/WRITE ERROR	Internal errors
-08 INVALID COMMAND	Invalid command
-10 VALUE TOO SMALL	Entered value too small
-11 VALUE TOO LARGE	Entered value too large
-12 VALUE NOT VALID	Value not valid
-13 COMMAND NOT ALLOWED IN CURRENT OPERATING MODE	Invalid command in current operating mode

10. Cleaning / repairing the unit



Caution:

Improper maintenance or repair can result in electric shock or damage to the unit.

- Repairs and any other work are to be carried out only by qualified service personnel authorized by JULABO.
- Always turn off the unit and disconnect the mains cable from the power source before performing any service or maintenance procedures, or before moving the unit.
- Prevent humidity from entering into the water bath.

Cleaning: The controller is designed for continuous operation under normal conditions. Periodic maintenance is not required.

Clean the outside of the unit using a wet cloth and low surface tension water.

Repairs: Before asking for a service technician or returning a JULABO instrument for repair, please contact an authorized JULABO service station.

Returning a unit: When returning the unit:

- Clean the unit and, if necessary, decontaminate the unit in order to avoid endangering service personnel.
- Attach a short fault description.
- During transport the unit has to stand upright. Mark the packing correspondingly.
- When returning a unit, take care of careful and adequate packing.
- JULABO is not responsible for damages that might occur from insufficient packing.



JULABO reserves the right to carry out technical modifications with repairs for providing improved performance of a unit.